

QUOTATION

Wolberg Electrical Supply Co., Inc.

ALBANY WAREHOUSE
 35 Industrial Park Rd P.O. Box 6309
 Albany, NY 12206-2021
 518-489-8451

Order Number	
2600042	
Order Date	Page
1/17/2025 07:47:11	1 of 1

Quote Expires On 1/20/2025

Bill To:

CASH SALES - ALBANY COUNTER/1
 ALBANY CTR/1

Ship To:

CASH SALES - ALBANY COUNTER/1
 ALBANY CTR/1

110 / 120 w/h

Customer ID: 14457

PO Number	Ship Route	Taker
JOSEPH R 518-669-4286		MPLAPOINT

Quantities				Item ID Item Description	Pricing UOM Unit Size	Unit Price	Extended Price
Ordered	Allocated	Remaining	UOM Unit Size				

6	0	6	E	MISC	E	284.5000	1,707.00
---	---	---	---	------	---	----------	----------

		1.0		MISC PART - ENTER DESC IN EXTENDED TECH 700MPTLM06S	1.0		
--	--	-----	--	--	-----	--	--

6	0	6	E	SAT S9496	E	7.1000	42.60
---	---	---	---	-----------	---	--------	-------

		1.0		SATCO S9496 6.5W 3K LED MR16 12V DIMMABLE	1.0		
--	--	-----	--	--	-----	--	--

Order Line Notes: LAMP FOR ABOVE FIXTURE

6	0	6	E	MISC	E	335.9500	2,015.70
---	---	---	---	------	---	----------	----------

		1.0		MISC PART - ENTER DESC IN EXTENDED TECH 700MPTLML6S-LED30	1.0		
--	--	-----	--	--	-----	--	--

6	0	6	E	WAC HMPBN	E	35.1000	210.60
---	---	---	---	-----------	---	---------	--------

		1.0		WAC HMP-BN NICKEL MONOPOINT	1.0		
--	--	-----	--	-----------------------------	-----	--	--

6	0	6	E	MISC	E	41.2500	247.50
---	---	---	---	------	---	---------	--------

		1.0		MISC PART - ENTER DESC IN EXTENDED WAC H-8010-CS-BN	1.0		
--	--	-----	--	--	-----	--	--

6	0	6	E	MISC	E	82.4500	494.70
---	---	---	---	------	---	---------	--------

		1.0		MISC PART - ENTER DESC IN EXTENDED WAC H-7011-CS-BN	1.0		
--	--	-----	--	--	-----	--	--

Total Lines: 6

SUB-TOTAL: 4,718.10

TAX: 377.44

AMOUNT DUE: 5,095.54

U.S. Dollars



PRODUCT FEATURES

- From the brand formerly known as Tech Lighting
- High-tech display head that combines simplicity with practical technology
- Precise light beam that directs light where you want it
- This item is made of natural brass. It is a living finish that will patina and warm with age which adds richness. If it gets an uneven patina or spots, a brass cleaner can restore the finish
- Compatible with the Monorail and Monopoint systems by Tech Lighting
- Monopoint version - The LED Driver is housed within the junction box. (L. 3.05" | W. 1.5" | H. .98")

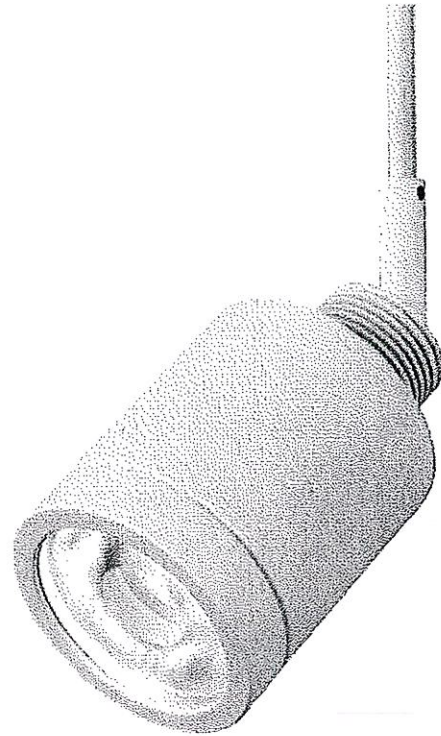

LAMPING

Lamp not Included. Rated for 50 watt max. Dimmable with Low-Voltage electronic or magnetic dimmer (based on transformer). 360° head rotation and 90° pivot

White

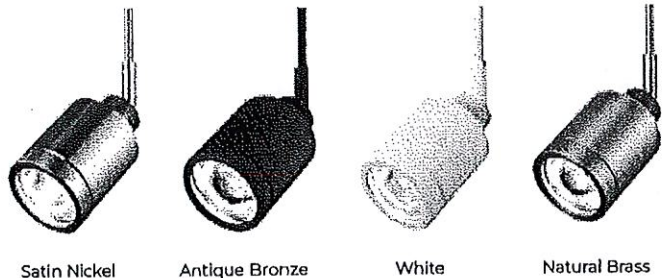

Satin Nickel

Antique Bronze

White

Natural Brass

ORDERING INFORMATION

700	SYSTEM	TLM LENGTH (A)	FINISH	LAMP
	<input type="checkbox"/> FREEJACK <input type="checkbox"/> MONOPOINT <input type="checkbox"/> MONORAIL	03 3" 06 6" 12 12"	<input type="checkbox"/> ANTIQUE BRONZE <input type="checkbox"/> NATURAL BRASS <input checked="" type="checkbox"/> SATIN NICKEL <input type="checkbox"/> WHITE	NO LAMP NO LAMP

Note. MP includes 4" Round Flush Canopy. For custom stem lengths, please contact the Quotes Department. White finish option ships with Satin Nickel system connector.

700 _____ TLM _____

JOB NAME _____

NOTES _____

2

WAC LIGHTING

Charge 8010 - 5CCT

9W H/J/L Track Luminaire

System Type & Voltage

- H 120 VAC
- J 120 VAC
- L 120 VAC

Model

H8010

Color Temp & CRI

CS
2700K/3000K/3500K/4000K/5000K - 90

Lumens

865

CBCP

1006

Finish

- BK Black
- BN Brushed Nickel
- DB Dark Bronze
- WT White

Fixture Type: _____

Catalog Number: _____

Project: _____

Location: _____

Example: H-8010-CS-BK

DESCRIPTION

Charge 8010 track luminaire offers superior light output in a small, unobtrusive design. Developed for residential spaces and lower-mounted commercial applications.

FEATURES

- 5-CCT Switchable between 2700K and 5000K
- 350° horizontal and 90° vertical aiming
- Driver concealed within the fixture
- 5 year warranty

SPECIFICATIONS

Construction	Die-cast aluminum with frosted TIR lens
Power:	9W
Input:	120 VAC, 50/60Hz
Dimming:	ELV: 100-10% , TRIAC: 100-10%
Light Source:	Integrated LED, 3 Step Mac Adam Ellipse
Rated Life:	50,000 Hours
Finish:	Electrostatically Powder Coated: White, Black, Dark Bronze, Electroplated Brushed Nickel
Operating Temp:	-4°F to 104°F (-20°C to 40°C)
Standards:	ETL, cETL, Dry Location Listed



FINISHES:

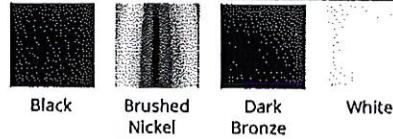

LINE DRAWING:

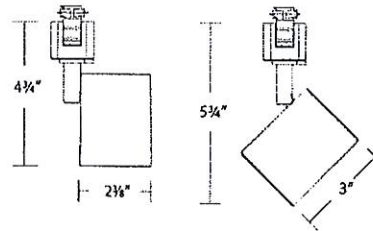

3

OCULARC – model: 7011-CS

H/L/J Track Luminaire

WAC

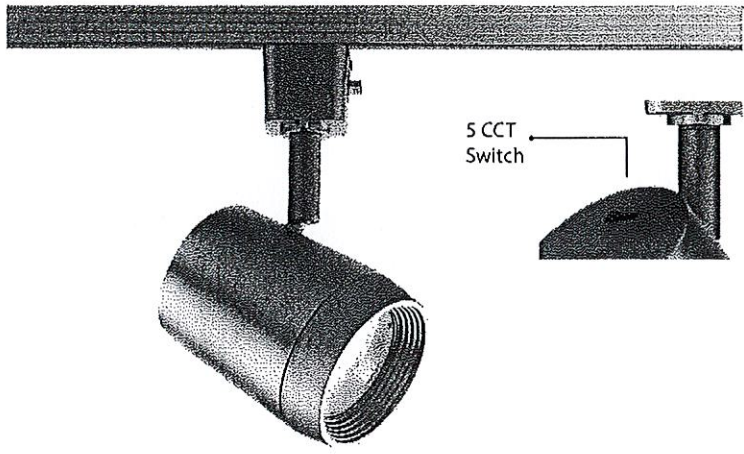

Fixture Type:

Catalog Number:

Project:

Location:

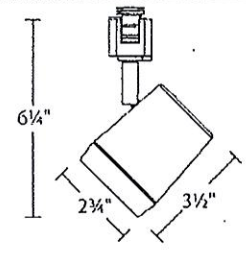

PRODUCT DESCRIPTION

Ideal for residential spaces and lower-mounted commercial installations, the OCULARC 7011-CS combines a high efficacy 5-CCT selectable COB LED with easy-to-use films for three separate beam spreads, along with an adjustable base to accommodate a variety of user preferences. With the driver and thermal/optical management encased in the die-cast housing, this compact luminaire offers a clean, efficient, versatile design that works with almost any décor. Available in H, J/J2, and L track configurations.

FEATURES

- **3 beam angle options included:**
 - 60° beam film pre-installed, interchangeable 30° film supplied, remove film for 17° spot beam
- Discrete, toolless integrated 5CCT switch: 2700K, 3000K, 3500K, 4000K, 5000K
- Integral driver and high output COB LED
- Outperforms halogen 65W MR16
- 350° horizontal and 90° vertical aiming
- 5 year warranty

REPLACEMENT OPTICS

17° Spot TIR Lens	TIR-HER2-OD50-S-W
30° Narrow Flood Film	FILM-16-N
60° Flood Film	FILM-16-F

SPECIFICATIONS

- Construction:** Die-cast aluminum with baffled front cover for glare control
- Input Power:** 11W at 120VAC, 50/60Hz
- Power Factor:** 0.98
- THD(A):** < 15% Total Harmonic Distortion (Current)
- Light Source:** High output 3 Step Mac Adam, Ellipse COB, 90+ CRI
Rated Life of 50,000 hours at L70
- Dimming:** Electronic Low Voltage (ELV) or TRIAC: 100 - 10%
Reference dimming report for compatibility.
- Standards:** ETL & cETL Dry Location Listed,
Title 24 JA8 Compliant
- Finish:** Electrostatically powder coated Black, Dark Bronze, and White.
Electroplated Brushed Nickel
- Operating Temperature:** -4°F to 104°F (-20°C to 40°C)

EXTENSION OPTIONS

Sold Separately. Ceiling Mount and H-Track compatible only

H H Track	18 18"	BK	Black
	24 24"	BN	Brushed Nickel
	36 36"	DB	Dark Bronze
	48 48"	WT	White

System	Model	Beam	Max Lumens	Max CBCP	Color Temp	CRI	T24	Finish
H H Track	7011	17°	1025	3935	CS 2700K/3000K/3500K/4000K/5000K	90	Yes	BK Black
L L Track		30°	955	1520				BN Brushed Nickel
J J/J2 Track		60°	920	670				DB Dark Bronze*
								WT White

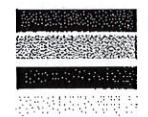

* Only available in H Track

-7011-CS-

Example: H-7011-CS-BN

wacighting.com	Headquarters, East Manufacturing Facility	South East Manufacturing Facility	Central Manufacturing Facility	West Manufacturing Facility
Phone (800) 526.2588	44 Harbor Park Drive	1600 Distribution Ct	1700 South J Elmer Freeway, Ste 100	1750 S Archibald Ave
Fax (800) 526.2585	Port Washington, NY 11050	Lithia Springs, GA 30122	Cedar Hill, TX 75104	Ontario, CA 91761